

**EZ** TOOLS &  
SPRAYERS



**PULMIC**<sup>®</sup>  
TAKE CONTROL

CATALOG **2025**



**EZ Tools & Sprayers**, based in Lake Zurich IL, is a company dedicated to manufacturing extremely high quality commercial and DIY garden, agriculture, outdoor cutting tools and sprayers.

Today our brands have a presence in more than 60 countries. We have a competitive advantage by controlling the entire manufacturing process. From design, mold manufacturing, injection of plastic parts, assembly, quality control and customer service.



Our international headquarters and factory is located in Valencia, Spain. (Europe) The factory has more than 322,000 square feet. It is composed of a multi disciplinary team. R&D, engineers, product designers, project managers and management.

**EZ Tools & Sprayers** is made up of 3 unique brands.



*"We are capable of adapting to the needs of our customers by controlling the entire product manufacturing process"*



PULMIC brand specialized in agricultural spraying. PULMIC products are designed for professionals who want to have the greatest possible control of applications with high quality performance and always respecting the environment.

1987 — Pulmic

1988 — Ez-Kut



KAMIKAZE brand specialized in outdoor cutting tools for different uses. It is one of the leading brands in the European market, where the combination of Japanese steel with components manufactured by us makes the products competitive and high performance.

2000 — Kamikaze

## About our brands

**EZ KUT** was born from the desire to build extremely high quality. EZ KUT's time tested designs, have survived the harshest environments and toughest individuals. From weekend warriors to the hardcore professionals. The EZ KUTTER is someone who hates junk tools and doesn't settle for anything less than the best.

# EZ KUT RATCHET PRUNERS

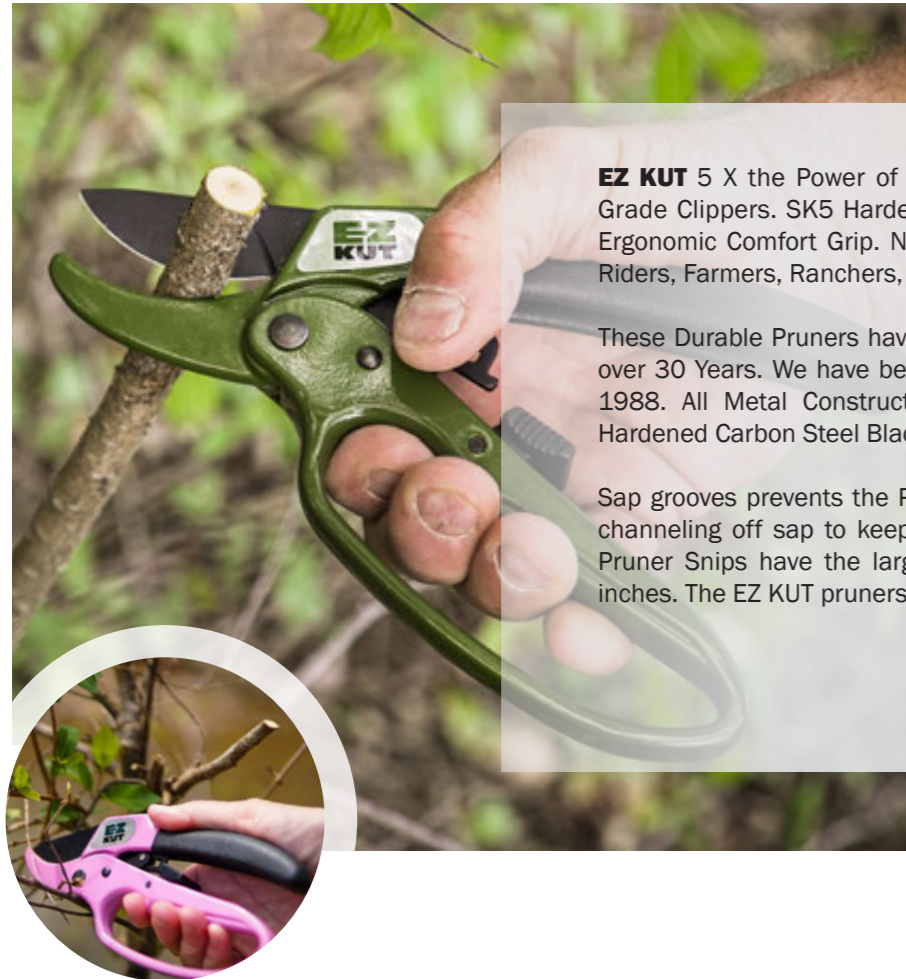

**EZ KUT** 5 X the Power of Conventional Shears, Heavy Duty Professional Grade Clippers. SK5 Hardened Carbon Steel, Non Stick Coated Blade and Ergonomic Comfort Grip. Number 1 Rated by Outdoorsman, Hunters, Trail Riders, Farmers, Ranchers, Home and Garden.

These Durable Pruners have been tested in the Harshesht Environments for over 30 Years. We have been standing by our quality and guarantee since 1988. All Metal Construction. High Quality Cast Aluminium Body. SK5 Hardened Carbon Steel Blade with a Non Stick Coating.

Sap grooves prevents the Pruning Cutters from sticking and saves time by channeling off sap to keep the blade clean of debris after each cut. Our Pruner Snips have the largest cutting capacity. Can easily cut up to 1.5 inches. The EZ KUT pruners can also circle cut Like No Other Cutter.

**ITEM #3130**

**ITEM #3130PNK**

Max. **1.5** inches  
Blade **1.97** inches

**#1**  
NUMBER 1 RATED BY  
OUTDOORSMAN  
FARMERS / GARDENERS

5 X THE POWER OF  
CONVENTIONAL SHEARS

Max. **1.5** inches  
Blade **1.97** inches

Anvil system

Anvil system



# EZ KUT RATCHET PRUNER & COMBOS

## SPECIFICATIONS

Available in Green or Pink  
All Metal Construction  
SK-5 Carbon Hardened Steel Blade  
Replaceable Blade  
Wrap-Around Knuckle Protector

Product video



LENGTH: 8 inches | WIDTH: 3 inches | WEIGHT: 12 oz

Qty. / Pack: 10

### Replaceable Components



**A** 3130PBK  
Pruner Blade  
replacement kit

Includes  
Pruner With sheath  
Carbide Sharpener

ITEM #3130\_CBOGR.mb\_EZ



Includes Free Sharpener!



ITEM # 3130-3\_EZ Green pruner with sheath  
ITEM # 3130-2\_EZ Green pruner and blade kit



Includes  
Pruner With sheath  
Carbide Sharpener

ITEM #3130\_CBOPK.mb\_EZ



Includes Free Sharpener!



ITEM # 3130 PNK3\_EZ Pink pruner with sheath  
ITEM # 3130 PNK2\_EZ Pink pruner and blade kit

# KAMIKAZE FORCE PRUNER

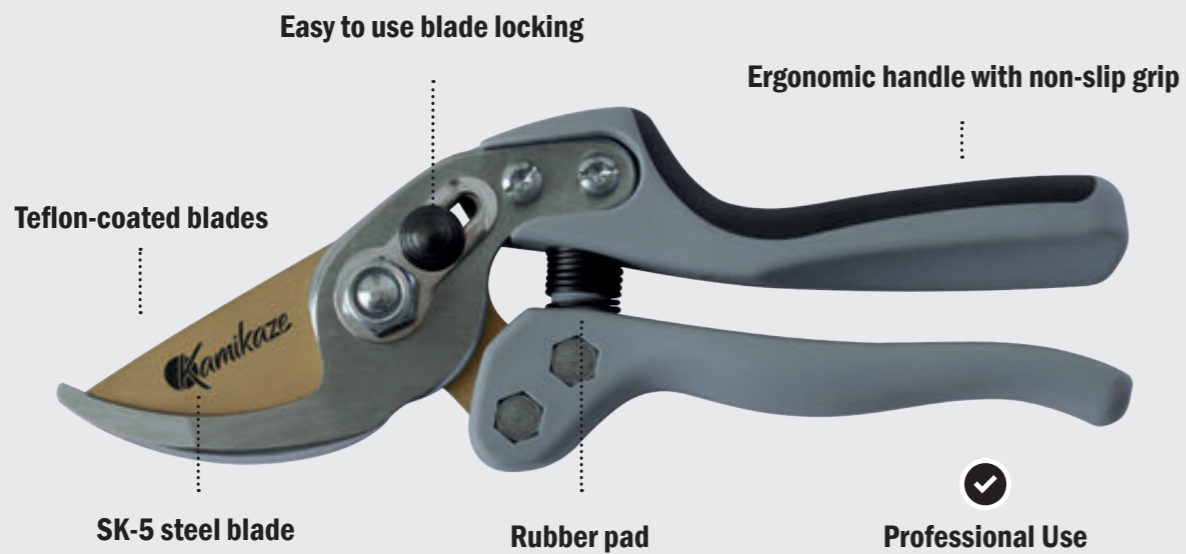

**VERTICAL TILT**  
Approaches the branch from a more natural position, reducing fatigue.

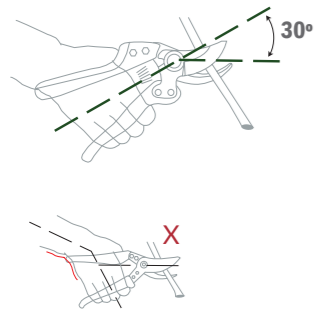

**LATERAL TILT**  
Reduces wrist rotation, avoiding injuries.

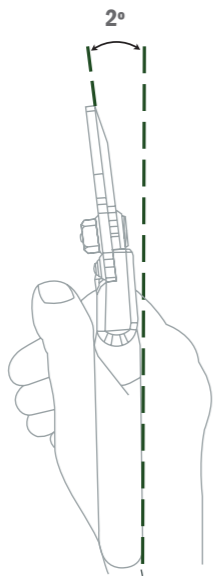

**KM FORCE**



**KM ADVANCE**



**FREE SHEATH**

**WHIT MAGNETIC CLIP FOR QUICK ATTCHMENT**



**EASY & ECO FRIENDLY**  
-READY TO USE-  
(10 units box)

# ONE HAND KAMIKAZE PRUNER

## KM1-M FORCE

ITEM #10930

Max. 0.8 inches | Blade 1.8 inches



Bypass system



FREE SHEATH

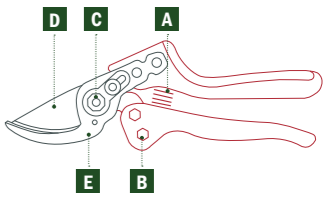

Replaceable Blade and Components

- A 7199 Stopper & Spring Kit
- B 9064 Screws Blister Set (Handle)
- C 10940 Central Screw Kit
- D 10943 Shear Blade
- E 10944 Shear Counter Blade

## KM1-M FORCE ANVIL

ITEM #13803

Max. 0.8 inches | Blade 1.8 inches



Anvil system



FREE SHEATH

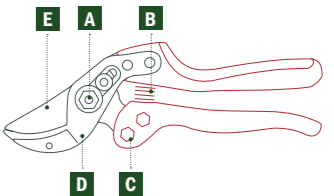

Replaceable Blade and Components

- A 6424 Central Screw Kit
- B 7199 Stopper & Spring Kit
- C 9064 Screws Blister Set (Handle)
- D 13805 Screw & anvil kit
- E 13806 Shear Blade

## KM2-L ADVANCE

ITEM #6416

Max. 1.0 inches | Blade 2.5 inches



Bypass system

**NEW**



FREE SHEATH

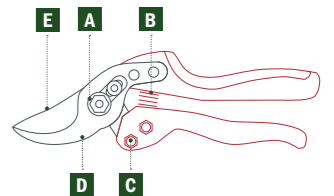

Replaceable Blade and Components

- A 6424 Central Screw Kit
- B 7199 Stopper & Spring Kit
- C 9064 Screws Blister Set (Handle)
- D 6423 Screw & anvil kit
- E 6422 Shear Blade

## KM1- MR ADVANCE

ITEM #8916

Max. 0.8 inches | Blade 2.0 inches



Bypass system

**NEW**



FREE SHEATH

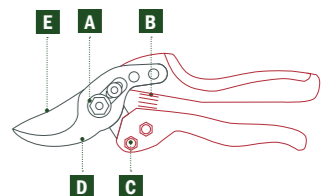

Replaceable Blade and Components

- A 6424 Central Screw Kit
- B 7199 Stopper & Spring Kit
- C 9064 Screws Blister Set (Handle)
- D 4230 Screw & anvil kit
- E 4228 Shear Blade

# KM-5 FORGED

ITEM #9717

This is the most traditional line of shears on the market. Handles made with aluminium or stamped steel make them perfect for moderate working requirements. Versatility is its main feature. Ergonomic designs that strive for minimum effort and maximum performance.

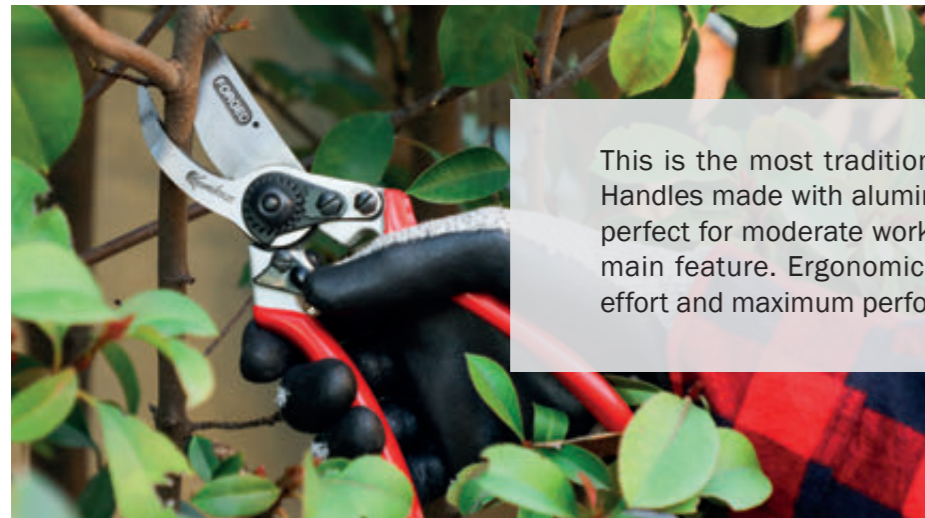

## SPECIFICATIONS

All Metal Construction  
SK-5 Carbon Hardened Steel Blade  
Replaceable Parts

ITEM #9717  
LENGTH: .79 inches | WIDTH: 3.97 inches | WEIGHT: 9.2 oz

Qty. / Pack: 10

### Replaceable Blade and Components

- A** 6127 Central Screw Kit
- B** 6128 Spring shear
- C** 8599 Screw kit
- D** 11202 Shear blade

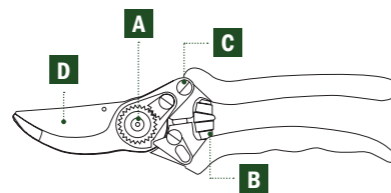

Max. 1.0 inches



FREE SHEATH



## SPECIFICATIONS

All Metal Construction  
SK-5 Carbon Hardened Steel Blade  
Replaceable Parts

ITEM #6207  
LENGTH: .79 inches | WIDTH: 3.97 inches | WEIGHT: 8.1 oz

Qty. / Pack: 10

FREE SHEATH

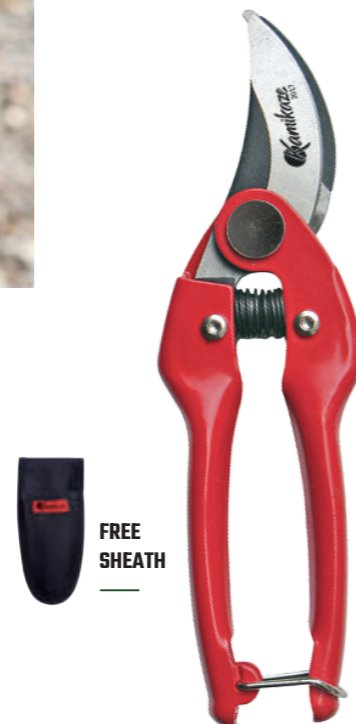

# KM-22

ITEM #6207

Max. 0.8 inches

### Replaceable Blade and Components

- A** 6278 Stopper & spring blister set

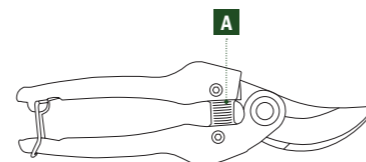

# KM-13

ITEM #6070

Max. 0.6 inches



# S-206

ITEM #6072

Max. 0.4 inches



These models are versatile. Ideal for harvesting fruit, vegetables, flowers and garden work.

z #6070  
LENGTH: 0.79 inches | WIDTH: 5.16 inches | WEIGHT: 6.35 oz

ITEM #6072  
LENGTH: 0.79 inches | WIDTH: 5.16 inches | WEIGHT: 4.20 oz

Qty. / Pack: 10

# FLOWER SNIPS

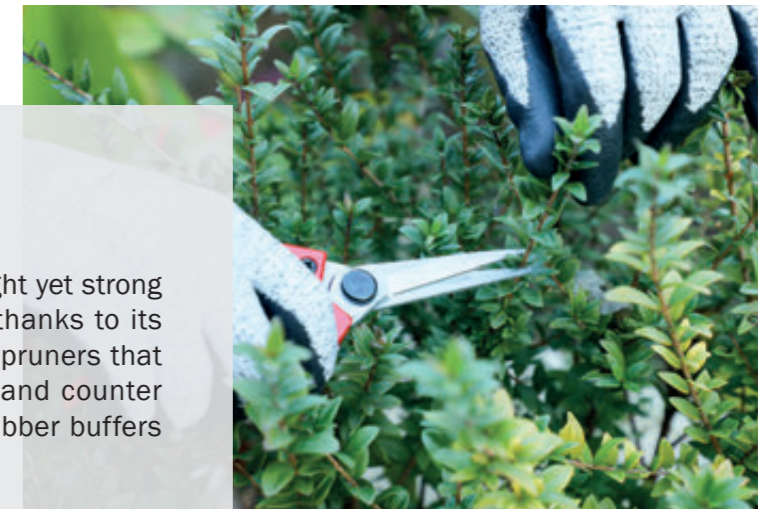

### Replaceable Blade and Components

ITEM #6070

- A** 6134 Screw & nut kit
- B** 6135 Spring blister (shears)

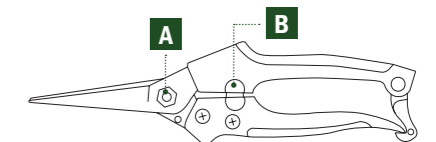

### ITEM #6072

- A** 6136 Spring

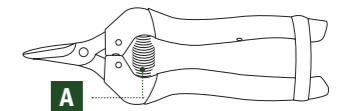

## CARBIDE SHARPENER

ITEM #3100EZ5



Designed to carry with you, this handy sharpener has a Carbide working end and ergonomic textured rubber handle to make sharpening your EZ KUT tools a breeze!

## EZ KUT SHEATH

ITEM #3130PPS



ITEM #3130PS



### SPECIFICATIONS

Made from Tough Temperature Molded Ballistic Nylon Material  
High Quality Metal Belt Clip  
Pull Thru Belt Opening  
Insert Cover Flap into Back Slot To Turn the Sheath into a Holster  
High Quality Metal Snap

WEIGHT: .15 lbs

LENGTH: 8 inches | WIDTH: 4 inches | DEPTH: 1 inch

Qty. / Pack: 1

## KAMIKAZE SHEATH

ITEM #15642



### SPECIFICATIONS

Increased safety, reduced risk of cuts  
Lightweight  
NEODYMIUM MAGNET  
Ergonomic

WEIGHT: 3.43 oz

LENGTH: 1.5 inches | WIDTH: 3.62 inches | HIGH: 8.54 inches

Qty. / Pack: 1

### with reinforced tip

Double handle for working with 1 or 2 hands.

#### Replaceable Components

- A 2263 Spring kit
- B 3740 Sticker



WEIGHT: 7.7 lbs  
HEIGHT: 17.32 inches  
WIDTH: 5.56 inches  
BORE Ø: 3.15 inches

Qty. / Pack: 6



EASY TO USE



PROFESSIONAL

## MANUAL PLANTER

ITEM #2433



# KAMIKAZE TWO HANDS PRUNERS

## SPECIFICATIONS

Fiberglass-reinforced  
Lightweight  
SK-5 mild steel  
Force multiplier system  
XTRA Power  
Comfort Grip handle

### ITEM #KM752

Blade anvil type  
Dried branches

### ITEM #KM760

Bypass type blade  
Use for dry branches

### ITEM #KM770

Bypass type blade

**NEW**

Product video



**FIBERGLASS  
REINFORCED**



**MULTIPLIER EFFECT**



**NEW**



### ITEM #KM752

1,20" | LENGTH: 18 inches | WEIGHT: 19.4 oz



### ITEM #KM752

1,10" | LENGTH: 22 inches | WEIGHT: 26.5 oz



### ITEM #KM752

2,0" | LENGTH: 28 inches | WEIGHT: 39.5 oz

# KAMIKAZE SERIE 7



### ITEM #KM752

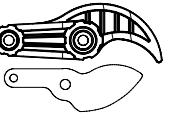

Spare parts kit #18379



### ITEM #KM760

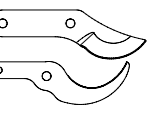

Spare parts kit #18378



### ITEM #KM770

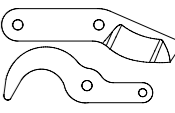

Spare parts kit #18380

# EZ KUT G2 LOPPER

ITEM #EZ7684



Max. **3.0** inches  
Blade **2.7** inches



- Replaceable Component**
- A** 7684 RB G2 Lopper Replacement Blade
  - B** 7684 SPR Spring
  - C** 7684 LINK Spacer

**THE EZ KUT G2 LOPPER BY EZ KUT IS BY FAR ONE OF BEST LOPPERS IN THE WORLD!! IT IS PROFESSIONAL COMMERCIAL GRADE.**

Telescoping handles extend from 18 to 42 inches. Reaches almost 10 feet with Aircraft Aluminium extending handles, patented Oiler Bolts for constant lubrication of the key pivot points. Only cutter with replaceable handles. All rubber grips, 6-stage ratcheting action. Cuts up to 3.5 inches with ease. SK5 Steel Blade, non-stick coated replaceable and sharpenable blade. Patent pending MAX Technology. This tool allows you to cut max diameter branches without losing your height when you fully open your lopper jaws. This is not a cheap junk lopper like most Chinese tools. It is a Commercial Grade, Professional Cutter. Great for Landscapers, Hunters, Arborists, Campers, Linemen, Trail Blazers, Trail Riders, Outfitters, and Home Maintenance.

## SPECIFICATIONS

- Extendable Arms with Thumb Locks
- SK-5 Carbon Hardened Steel Blade
- Replaceable Blade
- Buckle-Band Stay
- Adjustable Handles Extend from 18 to 42 inches
- 3 inch Max Cutting Diameter
- Patented Oiler Bolts
- Max Technology
- Real Non Stick Rubber Grips
- Dual Profile Jaw Plate

**G2 LOPPER**

LENGTH: 30 inches | WIDTH: 11.75 inches | WEIGHT: 5 lbs

Qty. / Pack: 6

# EZ KUT LIL G RATCHET LOPPER

ITEM #LG7684



**WORLD'S GREATEST COMPACT LIGHTWEIGHT LOPPER EVER DEVELOPED!! OH, DID WE SAY (DUAL CUTTING CAPABILITY)**



## SPECIFICATIONS

- Dual Cutting Capability
- Ratchet Up To 2" or Single Squeeze For Quicker Cutting
- SK-5 Hardened Carbon Steel
- Non-Stick Coated Blades
- Replaceable Blades and All Parts
- Great for Tight Spots, Packing, and Zero Fatigue
- Blade Harness: HRC 54+/-2
- Body & Handles: SK-5 Harden Carbon Steel
- Powder Coated
- OVERALL SIZE: ONLY!!!! 18.9" and LESS than 2 LBS!!

LENGTH: 3 inches | WIDTH: 7 inches | WEIGHT: 1.75 lbs

Product video

Max. **2.0** inches | Blade **2.3** inches

Qty. / Pack: 6



### Replaceable Blade and Components

- LG7684-B Blade
- LG7684-SPR Spring
- LG7684-RL Red lock





# EZ KUT SLING PAK

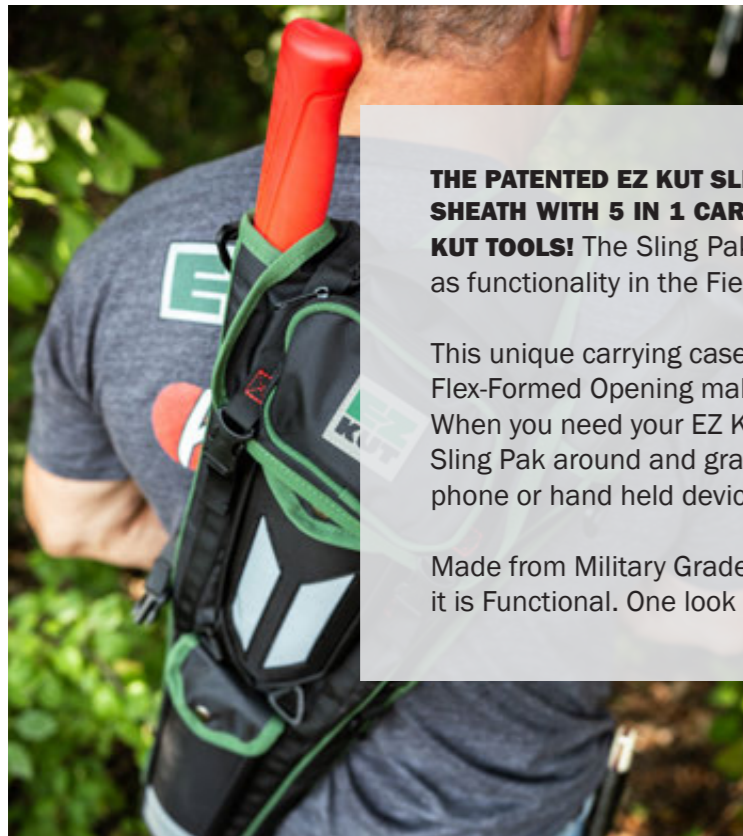

**THE PATENTED EZ KUT SLING PAK IS THE WORLD'S FIRST FULL SIZE LOPPER SHEATH WITH 5 IN 1 CARRYING CAPACITY TO HOLD ALL YOUR FAVORITE EZ KUT TOOLS!** The Sling Pak provides protection for your EZ KUT Tools as well as functionality in the Field, on the Farm, or in your Backyard.

This unique carrying case is built with an Innovative Pull-Thru Strap and its Flex-Formed Opening makes access to your EZ KUT Lopper quick and easy. When you need your EZ KUT Ratcheting Pruner or WOW SAW just swing the Sling Pak around and grab 'em! Additional pockets are provided for your cell phone or hand held device and EZ KUT Carbide Sharpener as well.

Made from Military Grade Ballistic Nylon, the EZ KUT Sling Pak is Rugged as it is Functional. One look at this Premium Tool and you can see the Quality!

ITEM #3110SLP-PK

ITEM #3110SLP



**EZ KUT FULLY LOADED SLING PAK G2**

ITEM #7684 FLY2

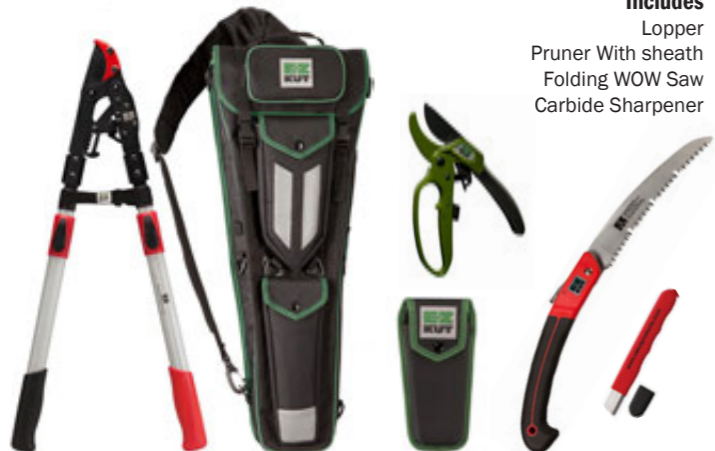

**Includes**  
 Lopper  
 Pruner With sheath  
 Folding WOW Saw  
 Carbide Sharpener

## SPECIFICATIONS

Military Grade Ballistic Nylon  
 Innovative Pull Thru Opening  
 Flex Formed Opening for Quick and Easy Access  
 Reflective Markers  
 Additional Attachment Points  
 Triple Stitched Stress Points

**LENGTH: 21 inches**    **DEPTH: 2.5 inches**  
**WIDTH: 8 inches**        **WEIGHT: .75 lbs**

**SLING PAK**

Product video



Qty. / Pack: 10

# HEDGE TRIMMER

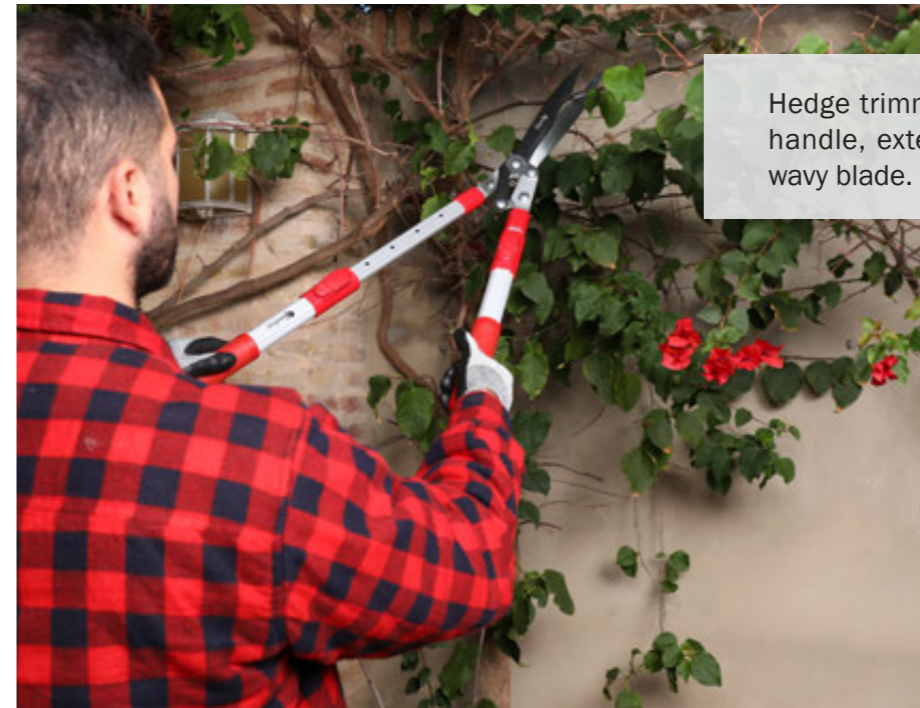

Hedge trimmers with 15 inches oval aluminium handle, extensible up to 23 inches. 10 inches wavy blade.



## KM-40

ITEM #8844

Max. 10 inches



Min. 25.6 inches

Max. 33.5 inches



**WEIGHT: 2.82 lbs**  
**HEIGHT: 27.56 inches** | **LENGTH: 3.97 inches** | **WIDTH: 7.94 inches**

Qty. / Pack: 10

### Replaceable Components

- A** 9082 Blade KM-40
- B** 9083 Screws kit

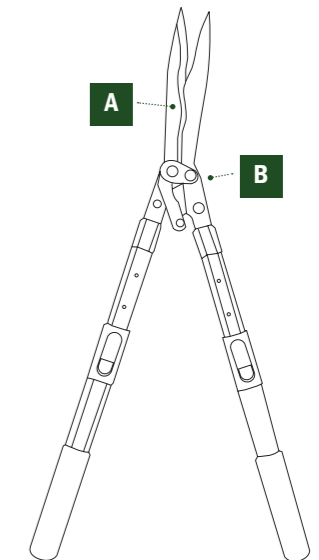



# EZ KUT KAMIKAZE MAX SAWS



**THE WOW SAW**



# EZ KUT KAMIKAZE MAX SAWS

**ITEM #6532 CURVED**

Max. 8.0 inches | Blade 13.0 inches

LENGTH: 19 inches  
WIDTH: 1 inch  
WEIGHT: 6.4 oz

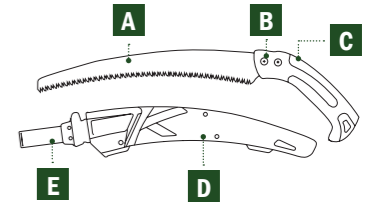

Replaceable Blade and Components

- A** 6536 Blade
- B** 9270 Screws kit
- C** 9271 Rubber handle
- D** 14832 Case
- E** 14849 Buckle with loop

**ITEM #2977 STRAIGHT**

Max. 6.0 inches | Blade 12.0 inches

LENGTH: 18 inches  
WIDTH: 1 inch  
WEIGHT: 6 oz

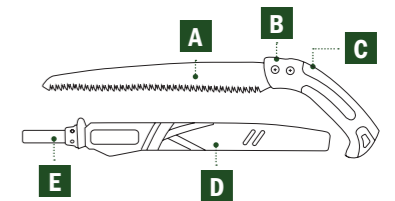

Replaceable Blade and Components

- A** 1634 Blade
- B** 9270 Screws kit
- C** 9272 Rubber handle
- D** 15641 Case
- E** 14849 Buckle with loop

**ITEM #EZ5210 FOLDING**

Max. 4.0 inches | Blade 10.0 inches

OPEN LENGTH: 17.75 inches  
CLOSED LENGTH: 10.5 inches  
TOOTH PITCH: 1.5 inches for all types of wood  
BLADE THICKNESS: 0.06 inches for fast cutting  
WEIGHT: 8 oz



**THE WOW SAW**



Replaceable Component

- A** 5210RB9270 Blade

made in SPAIN **EZ KUT KAMIKAZE EXTENDING POLE SAWS**

**SPECIFICATIONS**



- Single and double hook for finishing and branch removal
- Japanese steel and Hollow ground tooth
- SK-4 carbon-enriched steel blade
- Impulse hardened teeth
- Draw/pull stroke 3X stronger than conventional teeth
- Hard chrome plated, prevents rust and sap build up
- Blade is interchangeable on either pole
- Extends to 15 feet and 20 feet
- Oval aluminium tube with reinforced locking area
- Maximum rigidity, lightness, and strength
- Polyamide blade holder with a high strength design
- Less weight at upper end of telescoping pole making sawing easier
- New high tech integrated screw design avoids catching on other branches for easy in and out of your tree
- Non slip rubber coated handle, offering excellent grip and reduces fatigue
- New double locking on the top and bottom
- Compression and positive lock in each position

Qty. / Pack: 1

**15 FOOT ITEM #3006**



**20 FOOT ITEM #9249**

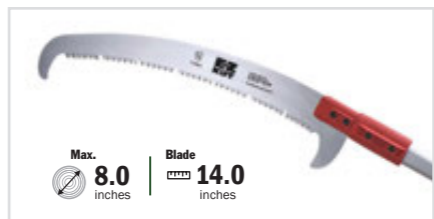
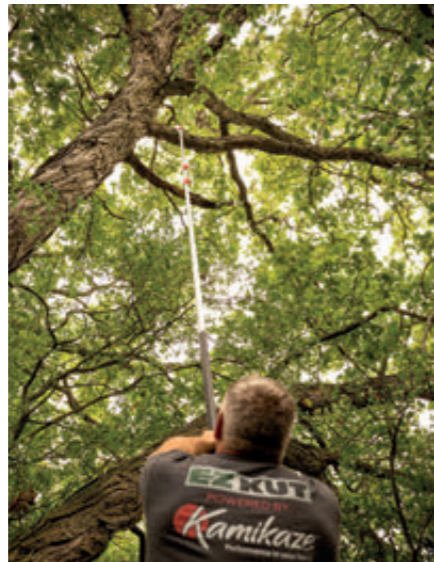

Min. **5FT**  
inches

Max. **15FT**  
inches



Min. **6FT**  
inches

Max. **20FT**  
inches

Blade fixing clip



**ITEM #3006**  
LENGTH: **15** feet  
WIDTH: **2** inches  
WEIGHT: **4.6** lbs

**ITEM #9249**  
LENGTH: **20** feet  
WIDTH: **2** inches  
WEIGHT: **5.7** lbs

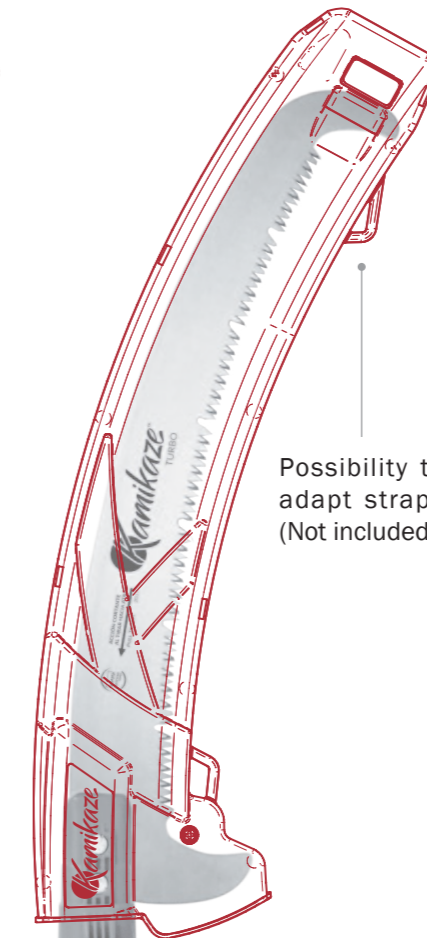

Wide slot facilitating blade removing



Optimized design for more safety

**Replaceable Blade and Components**

**ITEM #3006**

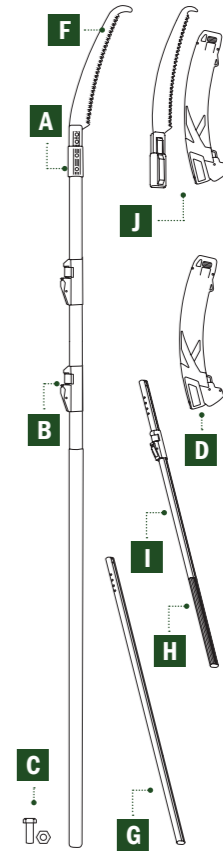

**ITEM #9249**

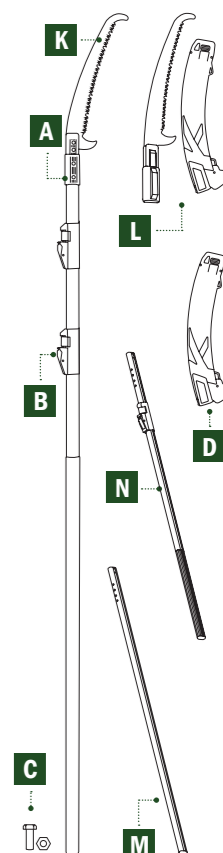

**ITEM #3006 / #9249**

- A** 8402 Saw blade attachment point
- B** 8540 Upper dual locking system
- C** 8583 Screw kit telescopic (screws+nuts 4u.)
- D** 13643 Red blade scabbard

**ITEM #3006**

- F** 3537 Saw blade (330BH)
- G** 8411 Aluminium tube (2 times 4,9 ft.)
- H** 8422 Rubber grip (2 times 3.2 ft.)
- I** 8423 Extensible telescopic (2 times 5.11ft)
- J** 8503 Blade + Blade attachment point + scabbard (330BH)

**ITEM #9249**

- K** 6537 Saw blade (360BH)
- L** 8504 Blade + Blade attachment point + scabbard (360BH)
- M** 9250 Aluminium tube (6.5 ft.)
- N** 9251 Extensible telescopic (3 times 6.5 ft.)

# KV295 // CORDLESS ELECTRIC PRUNER

**NEW**

ITEM #KV295USA



Product video



## SPECIFICATIONS

MOTOR BRUSHLESS: 150W  
 MAXIMUM DIAMETER: Ø 1.0 inch  
 WEIGHT (SHEARS + BATTERY): 33.5 oz

## BATTERY

POWER: 36Wh  
 14,4V / 2.5 Ah  
 CHARGING CURRENT: 1,0 Amp  
 CHARGING TIME 3-4h  
 AUTONOMY 2-3h

Per battery. Variable depending on usage

## INCLUDES

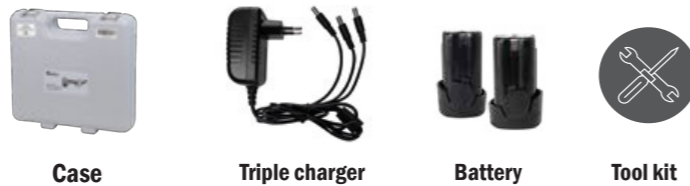

# KVS5100 // CORDLESS ELECTRIC CHAINSAW

**NEW**

ITEM #KV295USA



## SPECIFICATIONS

MOTOR BRUSHLESS: 350W  
 MAXIMUM DIAMETER: Ø 3,15 inches  
 WEIGHT (SHEARS + BATTERY): 52,9 oz  
 BAR LENGTH: 5"

## BATTERY

POWER: 36Wh  
 14,4V / 2.5 Ah  
 CHARGING CURRENT: 1,4 Amp  
 CHARGING TIME 3h  
 AUTONOMY 2-3h

Per battery. Variable depending on usage

## INCLUDES



# KVS7000P // CORDLESS ELECTRIC POLESAW

ITEM #KVS7000PUSA



Auto lubrication



Ergonomic handle



Smart display

## SPECIFICATIONS

MOTOR BRUSHLESS: 950W  
MAXIMUM DIAMETER: Ø 6.3 inches  
WEIGHT (SHEARS + BATTERY): 68.8 oz  
BAR LENGTH: 8"

## BATTERY

POWER: 86,4 Wh  
21,6V-4,0Ah  
CHARGING CURRENT: 1,4 Amp  
CHARGING TIME 3-4h  
AUTONOMY 1-3h

Per battery. Variable depending on usage

BAR LENGTH

5,75 FT  
8,2 FT

Product video

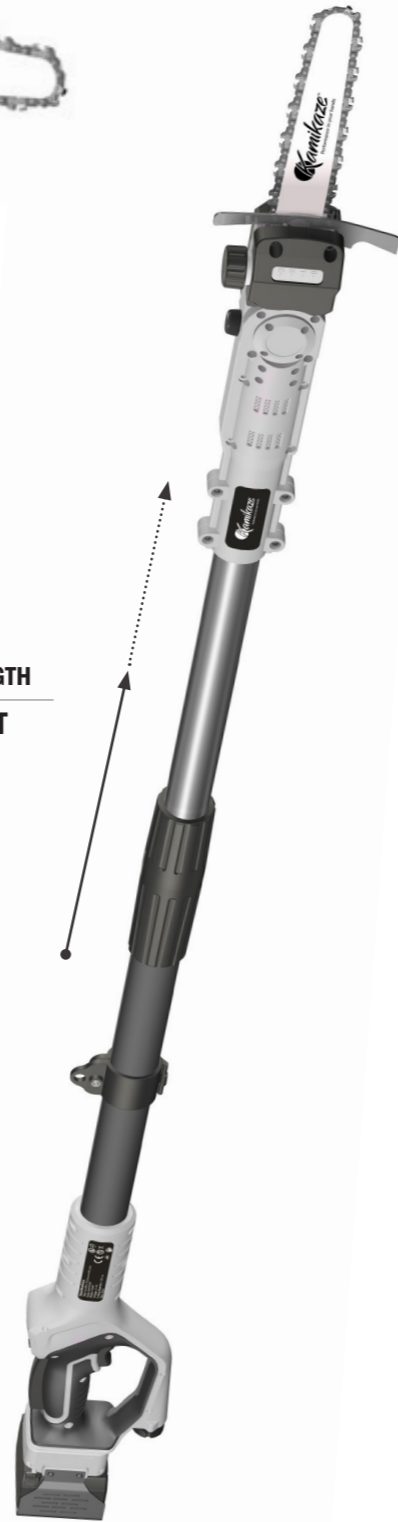

## INCLUDES



Bag / Harness



Triple charger



Battery



Tool kit



# PULMIC RAPTOR 16 ADVANCE



Product video



Eccentric pump  
Less wear



ITEM #13223

Useful capacity  
**4.25** gal



**INCLUDED ACCESSORIES**  
Adjustable nozzle  
Herbicide nozzle  
Four flow outputs nozzle  
Test tube to dose the machine

Padded straps



## SPECIFICATIONS

Pulmic Raptor 16 Advance is a manual sprayer with 4.25 gal. capacity for agrochemicals application.

This machine is the advanced version in the Raptor family. Lighter than other models but maintaining the same robustness thanks to its innovative design. With a handle with less wear for the user's hand, this is a machine which is suitable for a professional farmer.

Fibre-glass lance with fastening  
Eccentric pump with lower wear  
Padded straps  
Adjustable nozzle

HEIGHT: 24.41 inches | LENGTH: 7.34 inches | WIDTH: 17.26 inches  
WEIGHT: 7.7 lbs

Qty. / Pack: 1

### Replaceable Components

- A** 8740 Elbow with four flow outputs nozzle
- B** 2320 Pin
- C** 802 Lever clip
- D** 13249 Chamber (complete)
- E** 2416 PRODUR piston
- F** 13275 Cylinder (complete)



# PULMIC PEGASUS 15

ITEM #13964

Useful capacity  
**4** gal

Drain plug / filter



**3** Speed **3S**  
up to 58 psi



Removable battery



Product video

### INCLUDED ACCESSORIES

Adjustable nozzle  
Herbicide nozzle  
Four flow outputs nozzle  
Test tube to dose the machine  
Extension to extend the length of the lance

Padded straps



## SPECIFICATIONS

**HIGH PERFORMANCE DIAPHRAGM PUMP** Ideal for insecticide, fungicide and herbicide application thanks to its three working speeds, unique in the market. They always work with constant pressure and droplet size.

**3S SYSTEM:** Electronic regulation of the membrane pump pressure, facilitating 3 types of pressures from 14.5 to 58 PSI and optimizing battery autonomy. 3 application speeds; low pressure (suitable for herbicide treatments), intermediate pulsation (suitable for herbicide and insecticide treatments depending on the needs of the operator and the selected nozzle) and high pressure spray (recommended for insecticide treatments and medium-high crops.)

**UP TO 7 HOURS OF AUTONOMY:** lithium battery with removable Samsung technology of 18 volts 2.6 Ah with up to 7 hours of autonomy. The battery has a light indicator to see the state of charge.

HEIGHT: 10.63 inches | LENGTH: 6.75 inches | WIDTH: 15 inches  
WEIGHT: 5.5 lbs

### Replaceable Components

- 1300** Handle axis
- 1372** Full handle
- 1882** Full lance
- 13730** Membrane pump 12V 2,2L min
- 13943** Lithium battery 18V
- 14154** Hose
- 14155** Control Unit
- 14626** Pump head
- 15293** Elbow with red adjust. nozzle
- 15906** Charger USA

Qty. / Pack: 1

# PULMIC PEGASUS 35

**3** Speed up to **58 psi**

**3S**

ITEM #16861

Useful capacity **9.25 gal**



3 speeds



Removable battery



Product video



19.75 FEET HOSE



**INCLUDED ACCESSORIES**

- Adjustable nozzle
- Herbicide nozzle
- Four flow outputs nozzle
- Test tube to dose the machine
- Extension to extend the length of the lance

**Replaceable Components**

- 1300 Handle axis
- 1372 Full handle
- 1882 Full lance
- 13730 Membrane pump 12V 2,2L min
- 13943 Lithium battery 18V
- 14154 Hose
- 14155 Control Unit
- 14626 Pump head
- 15293 Elbow with red adjust. nozzle
- 15906 Charger USA



Ideal for insecticide, fungicide and herbicide application thanks to its three working speeds, uniques in the market. They always work with constant pressure and droplet size.

**UP TO 7 HOURS OF AUTONOMY:** lithium battery with removable Samsung technology of 18 volts 2.6 Ah.

**3S SYSTEM:** Electronic regulation of the membrane pump pressure. 3 types of pressures from 14.5 to 58 PSI and optimizing battery autonomy.

# PULMIC TELESCOPIC LANCE 16,5 FEET

ITEM #9103

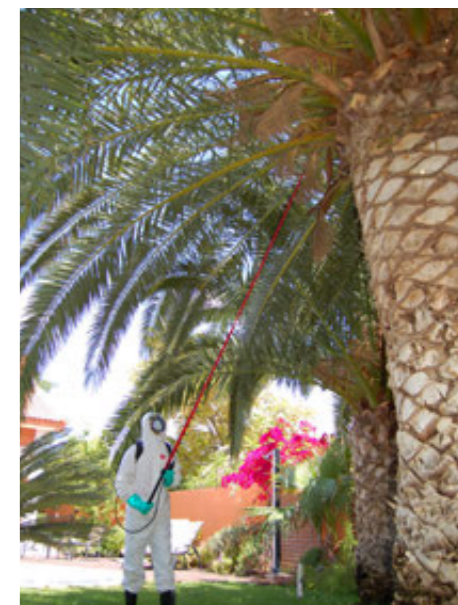
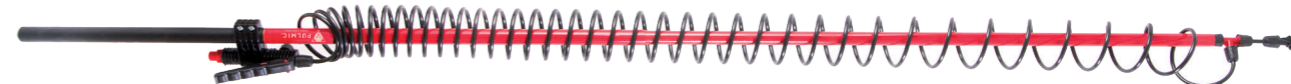

**ROOF CLEANING**

**UNIVERSAL TELESCOPIC EXTENSION LANCE**  
100 % COMPATIBLE WITH ALL THE SPRAYERS ON THE MARKET

**16,5 FEET**



Product video  
Pulmic Fenix Pure 35



# PULMIC FENIX PURE 35

ITEM #8621

The Pulmic Fenix Pure 35 is designed for the application of sensitive products, where its light but large-diameter hood gives a width of treatment of 13 inches.

This application gives excellent control of weeds, even the most difficult such as hollyhock and nettles. It is a highly-effective product, with results visible within three days of application.

**Centrifugal hydraulic sprayer to apply pure systemic herbicides.**

Droplet size with green nozzle



## SPECIFICATIONS

- 0.26 gal. capacity
- Interchangeable nozzles
- Disc with maze to prevent entry of damp to the motor
- Easy and rapid dosing
- Protective hood of 13 inches diameter

No batteries included  
Compatible with conventional battery: D / R20 / 1,5 W



LENGTH: 37.01 inches | WIDTH: 4.76 inches | WEIGHT: 3.3 lbs

### Flow

0.23 to 0.74 oz / min  
0.32 to 0.96 gal / acre  
depending on the nozzle used

### Nozzles



### Replaceable Components

- A** 1303 Shaft with gaskets
- B** 8648 Motor Kit
- C** 8661 Orange nozzle

Qty. / Pack: 1



# POINT OF SALE / DISPLAYS

ITEM #9341 + #16881

KAMIKAZE

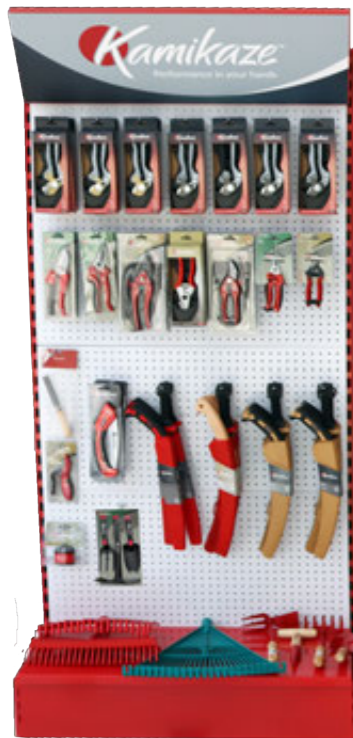

ITEM #12868

KAMIKAZE



ITEM #14196

PULMIC



ITEM #11224

KAMIKAZE



ITEM #13059

KAMIKAZE



ITEM #7851

PULMIC



Follow us



ezkutproducts



ezkutproducts



ezkutproducts

Sales policy:

- Transport incidents must be communicated within a maximum period of 24 hours, always sending photos of the product with its original packaging. Do not forget to note the incident on the transport delivery note.
- Returns of products will not be accepted for payment, whose original packaging is not in perfect condition.
- Please pack and protect the original containers.
- Products with transport stickers in their original packaging and unsealed will not be accepted.
- For claims of lack of material in the order, the maximum period is 72 hours from receipt.
- Returns of new material will only be accepted for credit within a period of 14 days from receipt of the item.
- The company reserves the right to modify the prices during the year if it deems it necessary.
- To claim guarantees, it must be done through the website:

[www.ezkutproducts.com](http://www.ezkutproducts.com)

All trademarks and company names in this catalog are the property of EZTools&sprayers reserves the right to modify this catalogue, its products or their characteristics or colors without prior notice. The size of the products may not be proportional to each other.

# EZ TOOLS & SPRAYERS



Follow us



[ezkutproducts](#)



[ezkutproducts](#)



[ezkutproducts](#)



📍 USA Headquarters  
744 Telser Road, Lake Zurich, IL 60047  
PHONE 847-550-8150  
[www.ezkutproducts.com](http://www.ezkutproducts.com)